

# STRIKE

ALBA

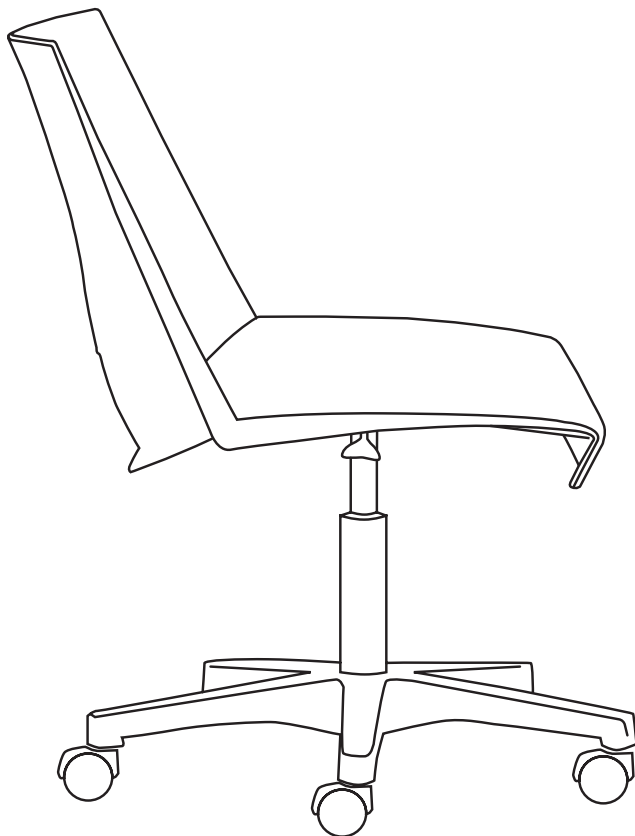

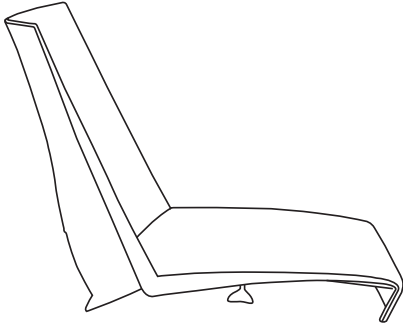

**1x**



**1x**

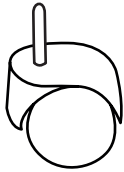

**5x**

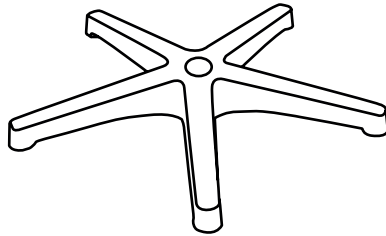

**1x**

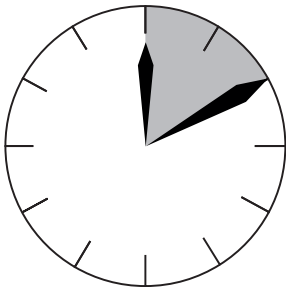

1.

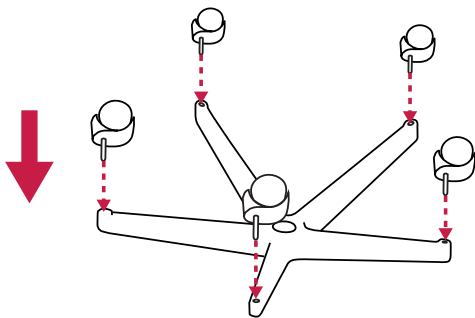

2.

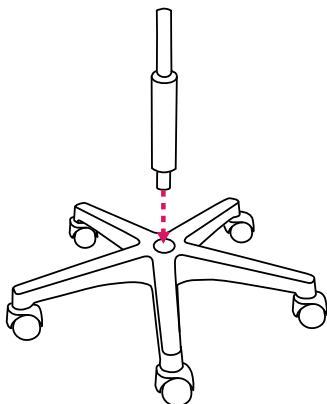

3.

