

ALBA

REFLEX

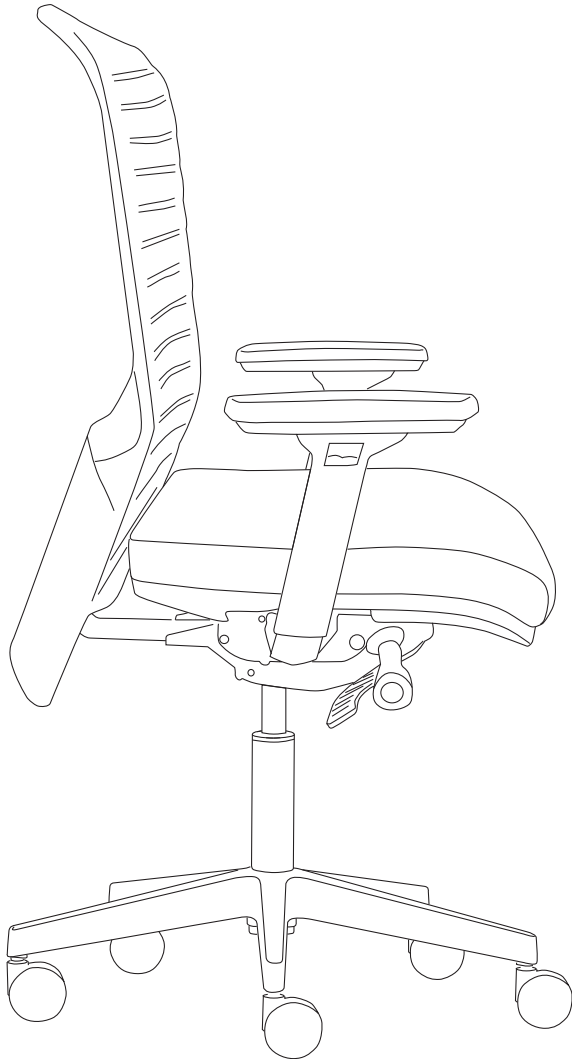



**1x**

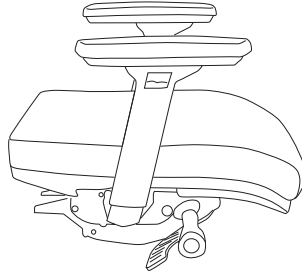

**1x**

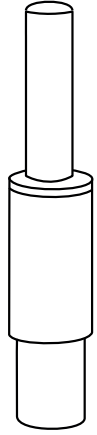

**1x**

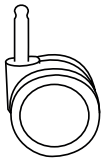

**5x**

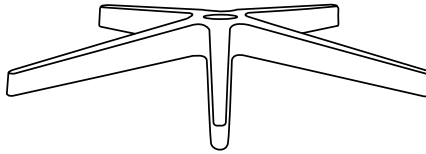

**1x**

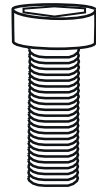

**3x**

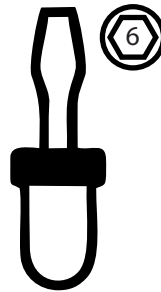
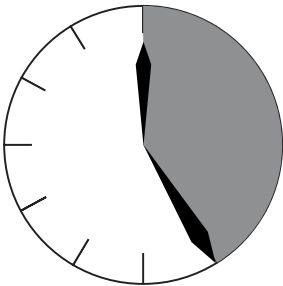

1.

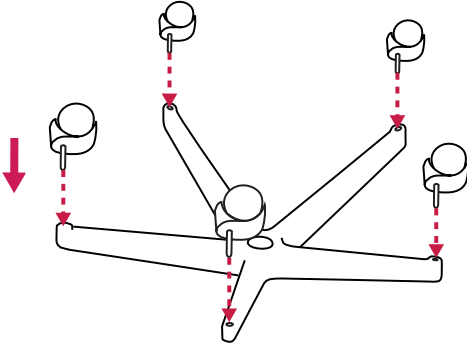

2.

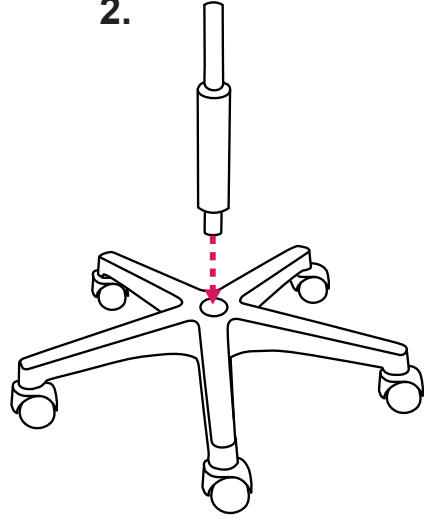

3.

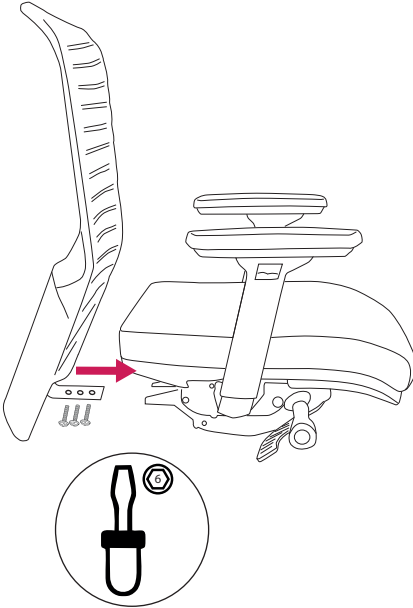

4.

